

Mitel 6710a

USER GUIDE

Release# 1.0



NOTICE

The information contained in this document is believed to be accurate in all respects but is not warranted by Mitel Networks™ Corporation (MITEL®). Mitel makes no warranty of any kind with regards to this material, including, but not limited to, the implied warranties of merchantability and fitness for a particular purpose. The information is subject to change without notice and should not be construed in any way as a commitment by Mitel or any of its affiliates or subsidiaries. Mitel and its affiliates and subsidiaries assume no responsibility for any errors or omissions in this document. Revisions of this document or new editions of it may be issued to incorporate such changes.

No part of this document can be reproduced or transmitted in any form or by any means - electronic or mechanical - for any purpose without written permission from Mitel Networks Corporation.

TRADEMARKS

The trademarks, service marks, logos and graphics (collectively "Trademarks") appearing on Mitel's Internet sites or in its publications are registered and unregistered trademarks of Mitel Networks Corporation (MNC) or its subsidiaries (collectively "Mitel") or others. Use of the Trademarks is prohibited without the express consent from Mitel. Please contact our legal department at legal@mitel.com for additional information. For a list of the worldwide Mitel Networks Corporation registered trademarks, please refer to the website: <http://www.mitel.com/trademarks>.

© Copyright 2018, Mitel Networks Corporation
All rights reserved

Mitel 6710a User Guide
Release # 1.0

Introduction	1
Phone Specification.....	1
Phone Parts	2
Key Panel.....	2
Bottom View	4
Basic Operation.....	5
Dial	5
Call by Handsfree	5
Call by Headset	5
Music on Hold.....	5
Mute.....	5
Goodbye Key	5
Redial	5
Volume Setting.....	6
Set Ring Volume.....	6
Set Handfree Volume	6
Set Handset Volume.....	6
Set Headset Volume.....	6
Speed Dial Memory.....	7
Save a Memory.....	7
Dial from a Memory	7
Delete Memory	7
Message Waiting Memory (MWM)	8
Save MWM	8
Dial from MWM.....	8
Delete MWM.....	8
Message Waiting LED	8

Phone Setting.....	9
Set Flash time.....	9
Set Ring Melody	9
Phone Lock.....	9
Phone Unlock	9
Change Password	10

Introduction

Mitel 6710a is an easily managed line-powered analog phone. The functions and features available with this telephone are designed for easy use in all different telephone handling situations. It supports calls by either handset, headset or handsfree operation with excellent voice quality.

Phone Specification

General	
Color	Charcoal
Signal	Analog
Line supported	Single

Features	
Flash button flash time programmable	100ms, 200ms, 300ms (default), 400ms, 600ms, 900ms
Compatibility with hearing aid	Yes
DTMF dialing	Yes
Incoming call/MWI indicator	Yes
Support Handsfree	Yes
Support Headset	Yes
Volume control	Handset / Headset (4 levels) Handsfree (8 levels)

Hardware and Feature	
LED calling signalization	Support
Hold with key	Support
Release with key	Support
Speed dial keys	Support (up to 8)
Redial with key	last 1 number
Navigational key	Yes
Ringer melody	8 types
Ringer volume	2 levels
Ringer silence	Yes

Accessories	
Connection cable, RJ11/ RJ45	1 pcs, 2 meters
Number card	1 pcs
Wall mounting kit	screws & anchors included

Phone Parts

When you unpack your phone, you should ensure that you have all the following items. If any part is missing, contact the supplier of your phone.



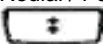







Figure 1 : Phone Parts

Key Panel



Figure 2 : Key Panel Overview

The following table describes about the Front view Key Panel components in 6 different languages.

Symbols / Keys	Français	Español	Deutsch	Português	Nederlands	Italiano
Speed-dial Shift / M0-M7	Numérotation abrégée Shift / M0-M7	Teclas programables Shift / M0-M7	Kurzwahl Shift / M0-M7	Marcação rápida Shift / M0-M7	Snel-kiezen Shift / M0-M7	Numeri brevi Shift / M0-M7
Flash key 	R - Flash	Tecla Flash	R-Taste	Flash	Haakcontact	Tasto Flash
Redial / Pause key 	Touche Bis/ Pause	Rellamada/ Pausa	Wahlwiederholung/ Pausentaste	Rechamar/ Tecla de pausa	Nummerherhaling/ Pauzetoets	Bis/Pausa
Goodbye key 	Fin/Fin d'appel	Desconectar	Ende Taste	Desligar	Beëindigen	Tasto Riaggancio
0-9, * and # (dial keys)	0-9, * et # numérotation	0-9, * y # (digitos)	0-9, * und # (Zifferntasten)	0-9, * e # (teclas marcação)	0-9, * en # (bel toetsen)	0-9, * e # (tasti selezione)
Volume keys 	Réglage du volume	Volumen	Lautstärketasten	Volume	Volume toetsen	Tasti regolazione volume
Mute key 	Touche secret	(Mute) silencio	Stummtaste	Silencio	Mute-toets	Tasto mute
Option key 	Touche option	Tecla de opción	Optionswahltaste	Opções	Instellingen	Tasto opzioni
Phonebook key 	Répertoire	Agenda	Telefonbuchtaste	Agenda	Telefoonboek	Tasto Rubrica
Save key 	Sauvegarde	Salvar	Speichertaste	Guardar	Opslaan	Tasto salvataggio
Delete key 	Suppression	Borrado	Löschtaste	Excluir	Verwijderen	Tasto cancella
Music on hold 	Musique d'attente	Música en espera	Musik bei Warten	Música em espera	Muziek tijdens wachten	Musica d'attesa

Bottom View

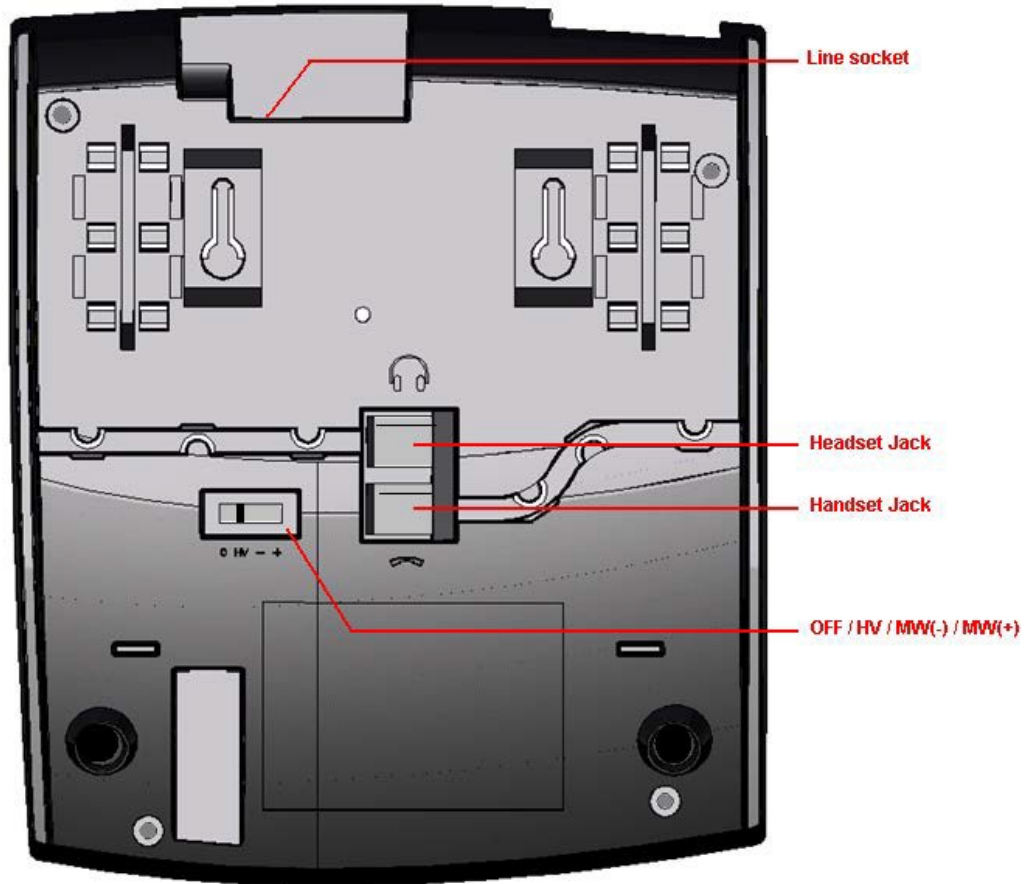



Figure 3: Bottom View

The following table describes about the Bottom view Key Panel components in six different languages.



Symbols / Keys	Français	Español	Deutsch	Português	Nederlands	Italiano
Line socket	Prise de ligne téléphonique	Puerto conexión de línea	Anschlussbuchse	Conector de linha telefônica	Lijnpoort	Presà linea telefonica
OFF / Hi Volt / MW (-) / MW (+)	Off / Haute Tension / MW (-) / MW (+)	DE / Alto voltaje / MW (-) / MW (+)	AUS/Spannung/ MW (-) / MW (+)	OFF / Hi Volt / MW (-) / MW (+)	UIT / Hi Volt / MW (-) / MW (+)	OFF / Alta Tensione / MW (-) / MW (+)
Handset Jack	Prise Casque	Puerto de auricular	Kopfhörerbuchse	Conector do fone de ouvido	Hoofdtelefoon aansluiting	Presà Cuffia
Handset Jack	Prise combiné	Puerto de microtelefono	Hörerbuchse	Conector do monofone	Telefoonhoorn aansluiting	Presà Microtelefono

Basic Operation



Dial

Pick up the handset (or press [] for handsfree / headset operation) and press numeric key, [0 to 9], [*], [#] or [Pause] to dial out.



Call by Handsfree

1. Press [] and enter the number by using the dial pad.
2. To hang up the phone, press [] again.
3. When you are talking on handset, you can switch to handsfree mode by pressing [].



Call by Headset

1. Insert a headset to the phone
2. Press [] and enter the number using the dial pad.
3. To hang up the phone, press [] again.
4. When you are talking on handset, you can switch to headset mode by pressing [].



Music on Hold

1. When a call is in progress, press [] to hold the call (LED on).
2. Press [] again or toggle the hook switch to resume the call (LED off).

Mute

1. When a call is in progress, press [] to mute (LED flashing).
2. To speak to the caller, press [] again (LED off).

Goodbye Key

1. During off-hook by handset, press [] to process another call.
2. During off-hook by handsfree/headset, press [] to hang up.

Redial

1. Press [] to redial the last called number.

Volume Setting

Set Ring Volume

Three levels of ring volume provided: **High, Low, Off.**

1. Place the handset on the phone.
2. Press 'Volume +' to increase ring volume.
3. Press 'Volume -' to decrease ring volume.

To disable the ring for incoming calls,

1. Press the 'Volume -' until reach **Ring Off** level or press [] during on-hook.
2. The Mute LED remains ON during on-hook to indicate the ring is now in silence.

Note: If the phone was locked, users cannot change to **Ring Off**. Only **High** and **Low** levels could be selected. To unlock the phone, see **Phone unlock** in **Phone Setting**.

Set Handfree Volume

Eight levels of handsfree volume provided: **Level 1 to 8.**

1. Press [].
2. Press 'Volume +' to increase the handsfree volume.
3. Press 'Volume -' to decrease the handsfree volume.

Set Handset Volume

Four levels of handsfree volume provided: **Level 1 to 4.**

1. Pick up the handset.
2. Press 'Volume +' to increase the handset volume.
3. Press 'Volume -' to decrease the handset volume.



Set Headset Volume

Four levels of handsfree volume provided: **Level 1 to 4.**

1. Plug in the headset.
2. Press [].
3. Press 'Volume +' to increase the headset volume.
4. Press 'Volume -' to decrease the headset volume.

Speed Dial Memory

Save a Memory

1. Place the handset on the phone.
2. Press one memory key (M0 to M.7).
3. Press [] and enter the number to be saved.
4. Press [] key again to complete saving.
5. The “save” is done successfully with confirmation tone.

Dial from a Memory

1. Pick up the handset or press [].
2. Press the memory key (M0 to M7) to be dialed.

Delete Memory



1. Place the handset on the phone.
2. Press the memory key (M0 to M7) to be deleted.
3. Press [].
4. The “delete” is done successfully with confirmation tone.

Note: If the phone is locked, you cannot add, edit or delete entries in speed dial memory. To unlock the phone, see “Phone unlock” in “Phone Setting”.

Message Waiting Memory (MWM)

The message waiting memory normally stores the number to reach the voicemail box.



Save MWM

1. Place the handset on the phone.
2. Press [].
3. Press [] and enter the number to be saved.
4. Press [] key again to complete saving.
5. The “save” is done successfully with confirmation tone.

Dial from MWM

1. Pick up the handset or press ‘Speaker/Handset’.
2. Press [].

Delete MWM

1. Place the handset on the phone.
2. Press [].
3. Press [].
4. The “delete” is done successfully with confirmation tone.

Message Waiting LED

When there is a message awaiting to be read, the message waiting LED is lighted ON or flashed in red.

The **Message Waiting** switch (at the back of the phone) is used to select the appropriate MW mode (HV / + / -). Check the MW type of the connected PBX to work with the phone. Select **OFF** on the MW switch to deactivate the message waiting function.

Phone Setting

Different combination of key sequences are used on different parameter settings as shown in the table below.

Parameters	Programming key sequence	Settings	Default
Set flash time	[save]+ [#] + [0] + [1] + [#] +[X]+ [#]	1: 100ms 2: 200ms 3: 300ms 4: 400ms 6: 600ms 9: 900ms	300ms
Set ring melody	[save]+ [#] + [0] + [2] + [#] +[X]+ [#]	1 ~ 8	RING 1
Phone lock	[save] + [XXXX] + [#]	[XXXX] = password in 4 digits	0000
Phone unlock	[delete] + [XXXX] + [#]	[XXXX] = password in 4 digits	0000
Change password	[save] + [#] + [0] + [5] + [#] + [XXXX] + [#] + [YYYY] + [#] + [YYYY] + [#]	[XXXX] = Old password in 4 digits [YYYY] = New password in 4 digits	

Set Flash time

1. During on-hook, press [save]+ [#] + [0] + [1] + [#] +[X]+ [#]
X could be set from 1 (100ms) / 2 (200ms) / 3 (300ms) / 4 (400ms) / 6 (600ms) / 9 (900ms).
2. If the setting is succeeded, a confirmation ring gets generated.

Set Ring Melody

1. During on-hook, press [save]+ [#] + [0] + [2] + [#] + [X]+ [#]. X could be set from 1 to 8 (melodies 1~8).
2. If the setting succeeded, a confirmation tone is generated.

Phone Lock

1. During on-hook, press [save]+[XXXX]+ [#] (XXXX is the set password in 4 digits).
2. A confirmation ring tone is generated if the phone is locked successfully.

Phone Unlock

1. During on-hook, press [delete]+[XXXX]+ [#] (XXXX is the set password in 4 digits).
2. A confirmation ring tone is generated if the phone is unlocked successfully.

Change Password

1. In idle state, press [save]+ [#] + [0] + [5] + [#] + [XXXX]+ [#] + [YYYY]+ [#] + [YYYY]+ [#].
(XXXX is the old password; YYYY is the new password. The new password had to be input twice as the second time was regarded as “confirmed password”).
2. If the password is changed successfully, a confirmation ring tone is generated.

WALL MOUNT DRILLING TEMPLATE

PRINT IN SCALE 1:1



EC-Declaration of conformity

Déclaration de conformité CE

EG-Konformitätserklärung

Declaración de conformidad CE



MITEL France (1 rue Arnold Schoenberg – 78280 Guyancourt – France) hereby declares that:

This product, Mitel 6710a, equipment is in conformity with the essential requirements and other relevant provisions of the European Directive 1999/5/EC (R&TTE Directive)

Le poste Mitel 6730a est conforme aux exigences essentielles de la directive 1999/5/EC

Dieses Gerät Mitel 6730a entspricht den grundlegenden Anforderungen der Richtlinie 1999/5/EG

Este equipo Mitel 6730a cumple con los requisitos esenciales de la directiva 1999/5/CE

<http://www.mitel.com>